

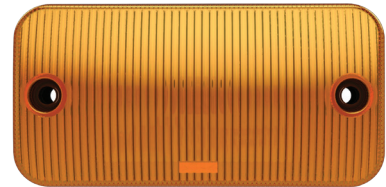

1005A MARKER

The TYRI 1005A Marker LED is the tiniest among all TYRI markers. It comes with flying leads and is UL-approved, making it a wise option for your market requirements.





This light can also be used as a dome light or indicator and is offered in both amber and clear lens options.





TECHNICAL DATA

Housing Material:	PC
Mounting Options:	Flush
Lens Material:	Amber & Clear PC
Temperature range:	-40 to +75 °C
Connector:	Bare wires

FEATURES

-  Overheating Protection
-  Over-voltage Protection
-  Polarity Protection
-  UL Optional

TEST STANDARDS

-  IP69K
-  EN55025 / CISPR 25 Class 5
ISO 11452-2 / ISO 11452-4
ISO 16750-2 / ISO 10605
ISO 7637-2

For further information visit www.tyriights.com or contact your local sales team.

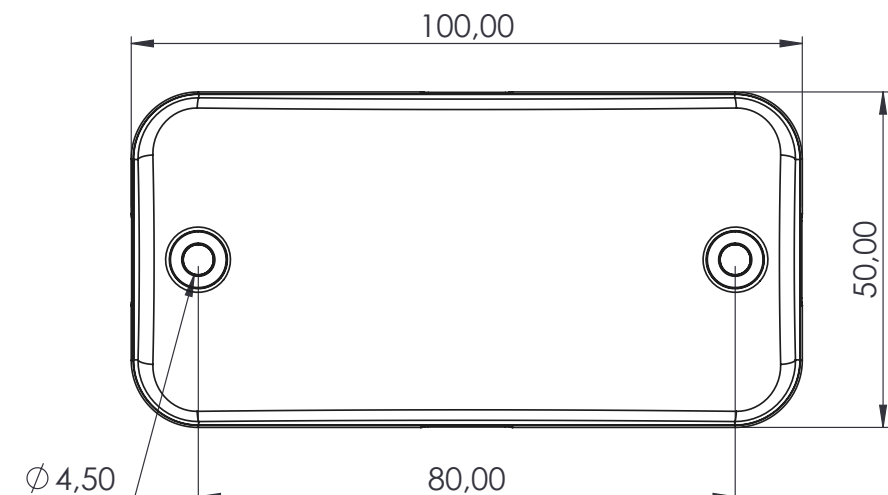
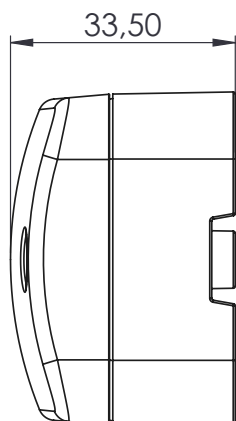



1005A MARKER

LENS COLOR	VOLTAGE		AMP DRAW		POWER	PART NO.	EMC	ECE
	Machine	Operating	12 V	24 V	Watts		EN55025 / CISPR25	ECE Rating
Amber	12 V	9-16 V	0.08 A	- A	1 W	61-011-1	5	-
Clear	12 V	9-16 V	0.08 A	- A	1 W	62-013-1	5	-
Amber	24-48 V	18-60 V	- A	0.04 A	1 W	61-012-1	5	-
Clear	24-48 V	18-60 V	- A	0.04 A	1 W	62-012-1	5	-

Product may not be available in all territories. Please check with your local TYRI office.

LED work lights are exposed to dirt, fertilizers, road salt, acids and more. For best performance and long lifetime, the lens and the cooling fins must be cleaned on a regular basis.